

Data Sheet

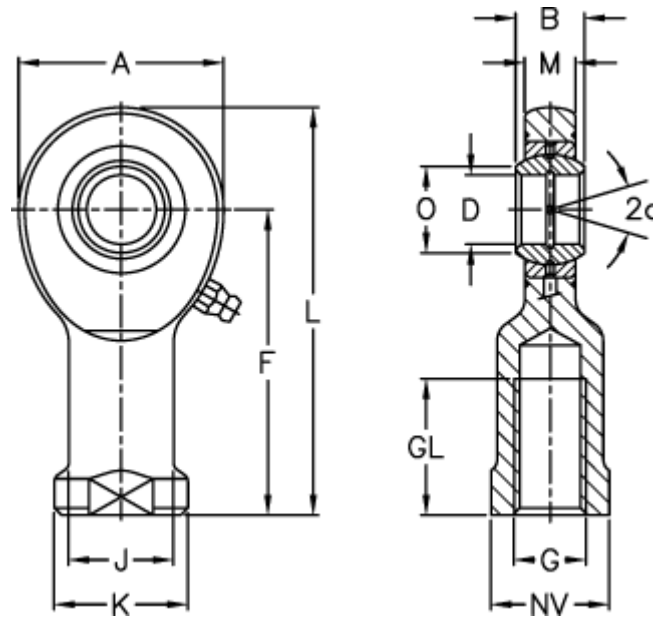

Article number: 03481040
Description: Fluro Rod end EIL 40-2RS
Note: 40

Measures



A	= 92	J	= 52
a (degrees)	= 7	K	= 65
B	= 28	L	= 188
D	= 40	M	= 23
Dynamic drive (kN)	= 100	NV	= 55
F	= 142	O	= 45
g	= M39x3	Static drive kN	= 178
GL	= 65	Weight	= 2000